

# Data Sheet



Article number: 03449150

Description: Fluro Heavy Duty Spherical Plain Bearing GE 150 SWE  
Hole Ø150

Note: 150

## Measures

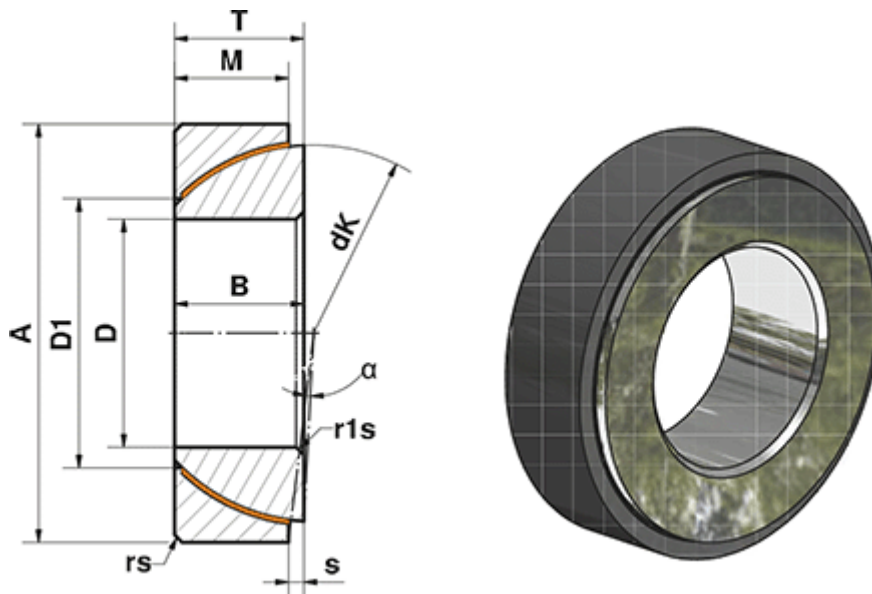

A	= 225	rs, r1s min	= 3
a (degrees)	= 1	S	= 20
B	= 48	Static load C0 (kN)	= 3814
D	= 150	T	= 48
D1	= 171.4	Weight (g)	= 8010
dK	= 211		
Dynamic load C (kN)	= 2288		
M	= 46		